

Pressure reducing valves

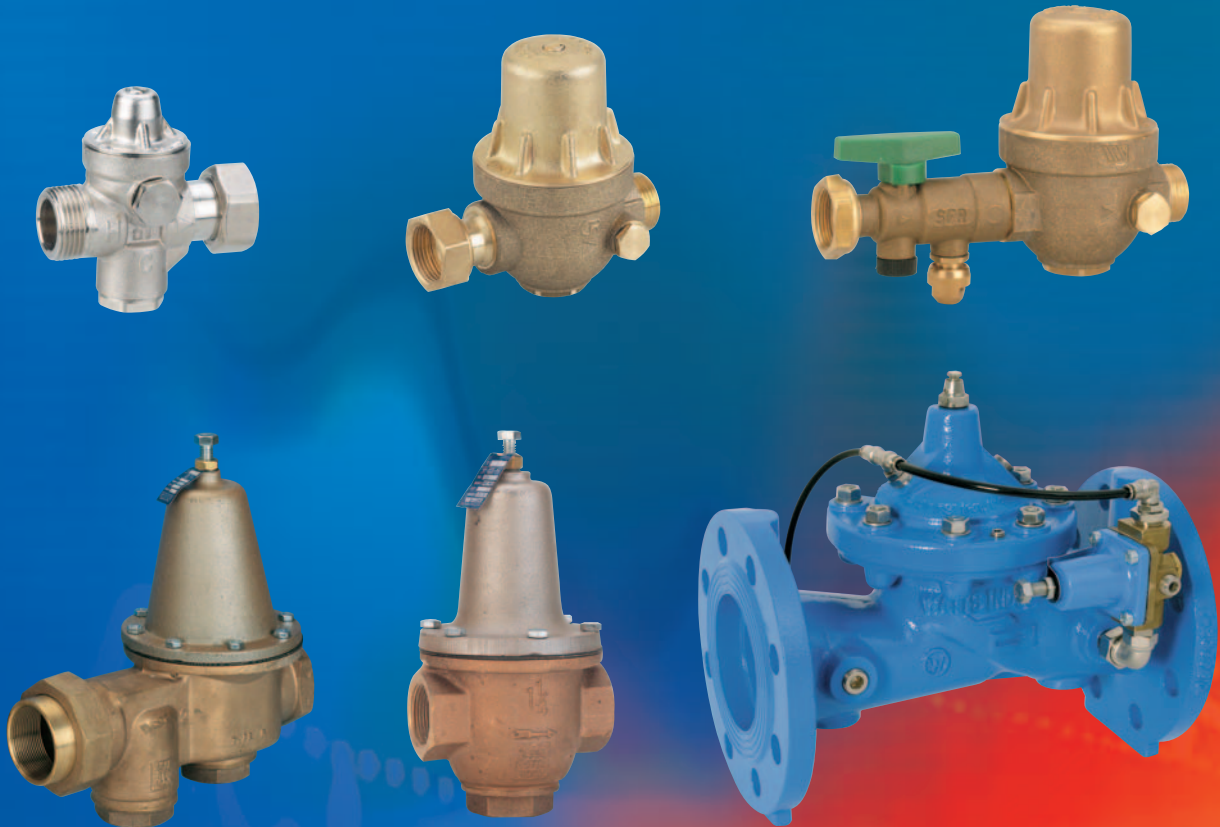

- [Guide of applications](#)

 **WATTS[®]**
INDUSTRIES

A Division of Watts Water Technologies Inc.

CONTENTS

	page
● The pressure reducing valve : Definition _____	3
● Water savings _____	3
● Pressure reducing valves or Regulators ? _____	3
● WATTS, the inventor of the regulator _____	4
● How to choose the diameter of pressure reducing valves ? _____	4
● Installation _____	5
● How to adjust a pressure reducing valve ? _____	5
● Precautions _____	5
● Pressure gauge : the essential accessory _____	6
● European standard EN 1567 and the brand NF _____	6
● Sanitary Conformity (ACS / WRAS) _____	6
● Pressure reducing valve, the WATTS INDUSTRIES expertise _____	6
● Case of electrical hot water storage heater _____	7
● Case of tower blocks _____	7-8
● Applications Guide _____	9
● Product information sheets _____	10

THE PRESSURE REDUCING VALVE : DEFINITION

This valve reduces the pressure of the water that goes through it, and is used to obtain a regulated and constant value at its outlet.

It is installed at the water mains (for a bungalow as for a flat). It protects the whole installation from problems due to excess pressure : noises in the pipes, water hammer, splashes, premature wear of household electrical appliances and taps.

The pressure reducing valves are completely automatic.

WATER SAVINGS

Water represents a major part of household budgets.

Not wasting it makes for real savings, but do you know that 30% of water used in a house is heated.

Less pressure means less water used, and therefore less energy consumed.

Through its low load losses, the WATTS INDUSTRIES pressure reducing valves allow the obtaining of a normal flow rate when water is drawn in several places simultaneously.

The toilet flushing is less noisy and the taps no longer splash.

Example with a tap running for 10 minutes.

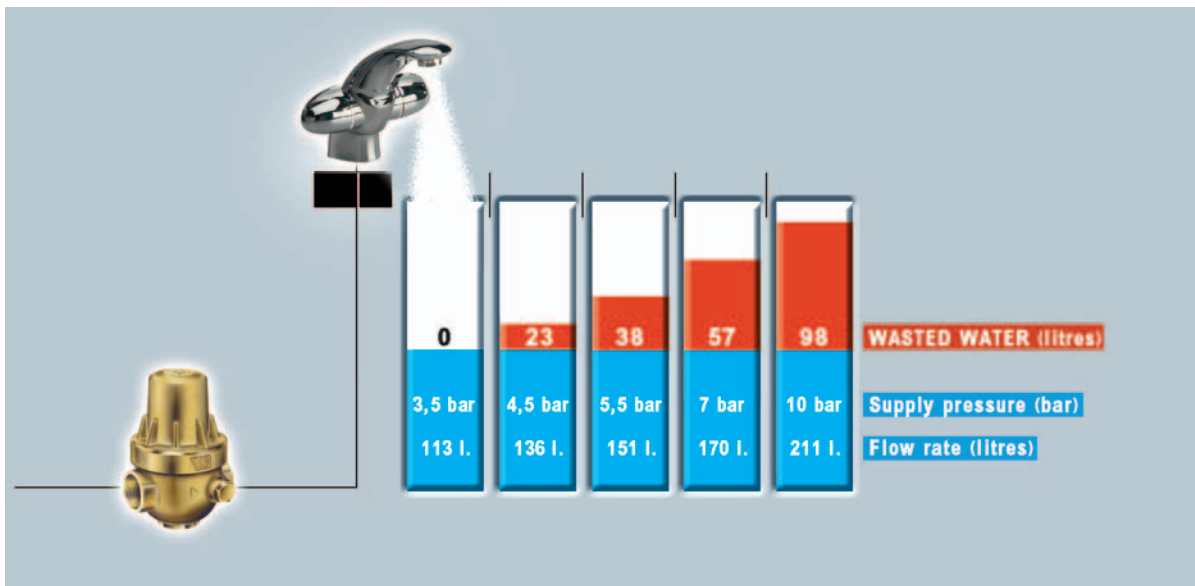

A considerable amount of the distributed water is directly dumped into the sewer without even having been truly used (see illustration above).

Reducing the pressure, all in obtaining comfort in use, allows for real savings.

In all cases, make a regular check of the condition of the tap and toilet flusher seals : a leak consumes a lot more water than you think ! (sometimes up to 3 m³ per day for a private household).

PRESSURE REDUCING VALVES OR REGULATORS ?

We use the standardised official term « REDUCER », but a pressure reducing valve is highly sensitive to upstream pressure variations, and regulates badly without water flowing (without drawing).

The WATTS INDUSTRIES direct action pressure reducing valves (PRECISIO, U5B, REGLEAU) regulate the downstream pressure as well with or without water flowing (without drawing). The downstream pressure only varies by 8% from the upstream pressure variation. These appliances are therefore **PRESSURE REGULATORS**.

WATTS, THE INVENTOR OF THE REGULATOR

- In 1876 : Invention, manufacturing and marketing of the first regulator.

It was somewhat complicated, took up a lot of space (nearly 2 metres high), but it worked.

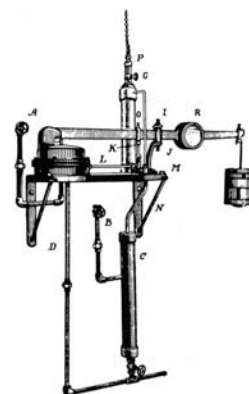

- 1930 : A half century had already gone by. Everything was designed – the principle of the **direct action** regulator valve with diaphragm operating the flap valve, the interior shape, the general look.



- From this date, most regulators made in the world were inspired by or copied this format.

The unique design of the WATTS pressure reducing valve makes it insensitive to scale or impurities, and needs no maintenance.

The diaphragm, spring, seat and flap valve are largely dimensioned for precise and constant regulation all in allowing high flow rates.

A corrosion-free spring (1) with a large spiral and highly sensitive : it guarantees precise adjustment. The pressure control is within the 1,5 to 5,5 bar range.

A high-temperature diaphragm (2) and a flap valve (3) : resist high temperatures (up to 80°C).

A stainless steel seat (4) : an exclusivity that protects from wear and water aggressivity. Give a long-life guarantee.

A single-unit body in non-dezincifiable brass (5) (DZR) : highly robust, this metal is resistant to corrosion and satisfies the new health standards on the compatibility of materials in contact with drinking water.

A yoke and flap valve assembly (6) : single-piece moving part in non-dezincifiable brass (DZR), the yoke includes a flap valve (3) that is largely dimensioned, allowing higher performance to standard requirements.

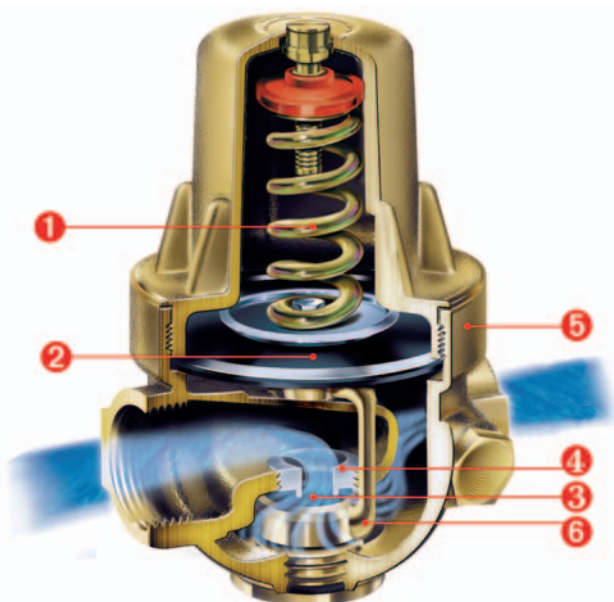

PRECISIO, U5B and REGLEAU use this direct action technique, with yoke and diaphragm.

HOW TO CHOOSE THE DIAMETER OF PRESSURE REDUCING VALVES ?

Practical rule : the pressure reducing valve is generally chosen according to the diameter of the installed pipe, provided, of course, that the latter is of the right size.

The choice of pipe diameters must follow the rules of the trade and must conform to the standards in force.

Refer to the flow rate curves of each pressure reducing valve, given in the technical documents.

INSTALLATION

WATTS pressure reducing valves may be installed in all positions. They are generally installed directly after the water meter, and thus protect the whole installation.

PRECISIO has 2 side connections and not a single one under the appliance unlike similar valves offered in the market.

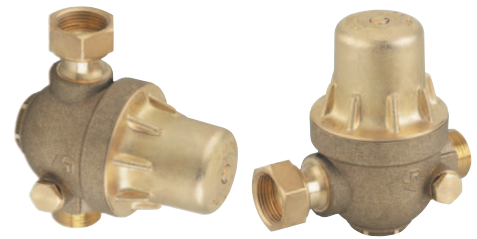

Advantage of a pressure gauge connection on the front : when 2 tubes are parallel with the wall, one above the other.

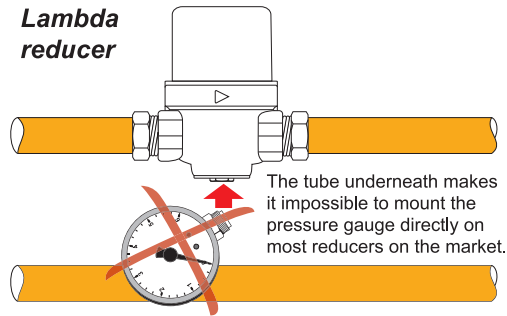
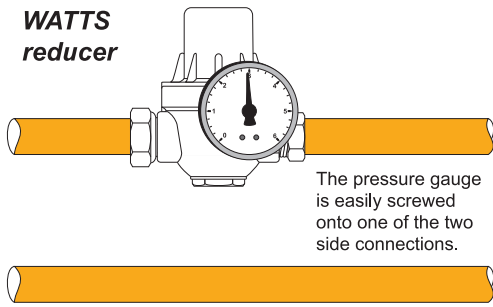

HOW TO ADJUST A PRESSURE REDUCING VALVE ?

THE ADJUSTMENT MUST BE DONE WITHOUT FLOW – NO DOWNSTREAM OUTFLOW.

The WATTS INDUSTRIES pressure reducing valves are factory preset at 3 bar. They remain adjustable within a 1,5 to 5,5 bar range.

- To increase the pressure, tighten the adjusting screw (clockwise as you look at the screw from above).
- To reduce the pressure, undo the adjusting screw (anticlockwise as you look at the screw from above), slightly open a tap for a moment, close again, then tighten the screw again until you obtain the desired pressure.

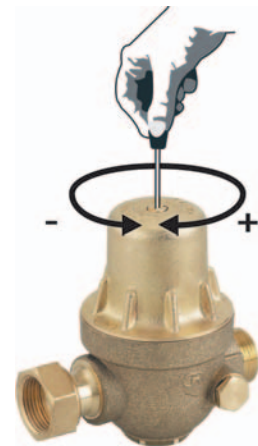

Two 1/4" gauge ports are located on each side of the valve when a pressure gauge is required to be fitted.

When opening the downstream tap (drawing), it is normal to see the pressure drop : this is the load loss of the appliance.

This value is given in the appliance flow rate curves (see technical documents).

PRECAUTIONS

WATTS INDUSTRIES direct action water pressure reducing valves are insensitive to scale or impurities, and need no maintenance or particular precautions provided that they are installed according to the rules of the trade.

However, if there is a risk of back pressure or water hammer in the downstream circuit, you are advised to protect the pressure reducing valve by a non-return valve placed immediately downstream.

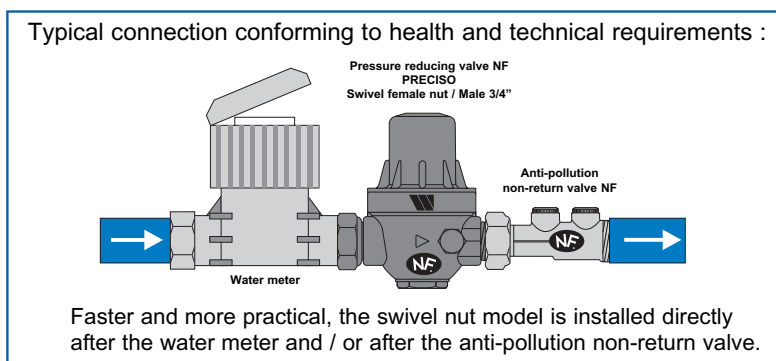

PRESSURE GAUGE : THE ESSENTIAL ACCESSORY

The pressure gauge allows direct reading of the pressure, and thus allows precise adjustment of the pressure reducing valve to local installation conditions.

WATTS INDUSTRIES designs, manufactures and markets a wide range of pressure gauges for buildings and industry.

Over the years, through the successive acquisition of FIMET and the German company Förster & Rothmann, the WATTS INDUSTRIES group has become a key player in the European instrumentation market.

The pressure gauge should not remain under pressure – the installation of an isolating valve is recommended.



EUROPEAN STANDARD EN 1567 AND THE BRAND NF



The brand NF guarantees the observance of standards for using household electrical appliances and taps.

PRECISIO has the right to use the NF EN 1567 brand, and ensures user comfort and preservation of installations : by distributing a normal flow rate during simultaneous drawings, thanks to its low load loss.

PRECISIO reduces the noise of running water. It facilitates the adjustment of mixers, by reducing the water hammer effect and avoiding rattling and vibrations in the pipes, characteristic phenomena of excessive pressure.

PRECISIO helps towards saving water by avoiding waste (leakage from pipes, taps and toilet flushers).

Through its design, it keeps its characteristics in time regardless of the water quality.

SANITARY CONFORMITY (ACS / WRAS)

These certificates assure the sanitary approvals - according to local requirements - A.C.S. (F) and WRAS (GB).



PRESSURE REDUCING VALVES, THE WATTS INDUSTRIES EXPERTISE

WATTS, inventor of the modern pressure reducing valve concept, designs and manufactures a complete range for all needs.

WATTS pressure reducing valves offer :

- The best for you and your customers, because depending on quality products ensures peace of mind.
- Easy installation : PRECISIO and REGLEAU are interchangeable with the main pressure reducing valves on the market. They can be installed in all positions.
- Savings : WATTS pressure reducing valves are sold at a competitive price. They ensure real water savings for your customers. They pay for themselves quickly.
- Conformity to standards, the quality of the materials used, the NF brand, the health conformity attestation, etc. are all guarantees for your installations.
- Reliability : manufacturing under quality assurance ISO 9001 (version 2000) in our plant at Fressenneville.
- By experience acquired on the job, the success of REDUFIX is due to installers insisting on this product, with more than 20 years on the market.

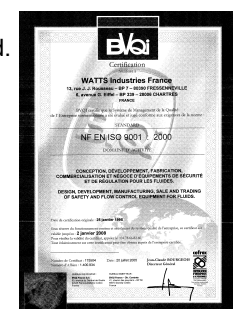

CASE OF ELECTRICAL HOT WATER STORAGE HEATER :

As the water temperature increases, the pressure also rises within the heater chamber (water expansion). For safety reasons, this pressure must be limited to a value under the safety pressure of the tank. This function is ensured by the safety unit valve, which is set at 7 bars (Standard NF-D 36401 - EN1487).

An aggravating factor – the consumption of water during the night drops considerably, which has the consequence of increasing pressure in the public drinking water network.

Now, it is generally during the night that the heating period is triggered (case of electric meters with off-peak time rates).

Thus the heating of the water adds to the increase of water mains pressure, and causes the pressure in the tank to reach the safety valve set-point, producing a water outflow higher than water expansion.

To avoid this water outflow (drinking and heated), it is necessary to install a pressure reducing valve, that will protect the immersion tank from excess pressure.

REDUFIX is an especially designed pressure reducing valve for this function.

It is a good-looking design, very discreet and compact, perfect fo built-in under counter electrical immersion heaters.

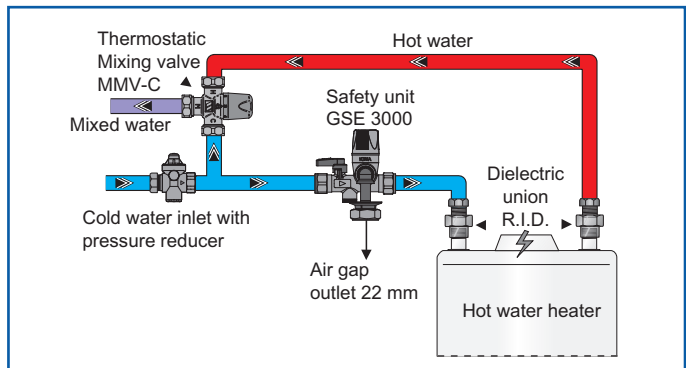
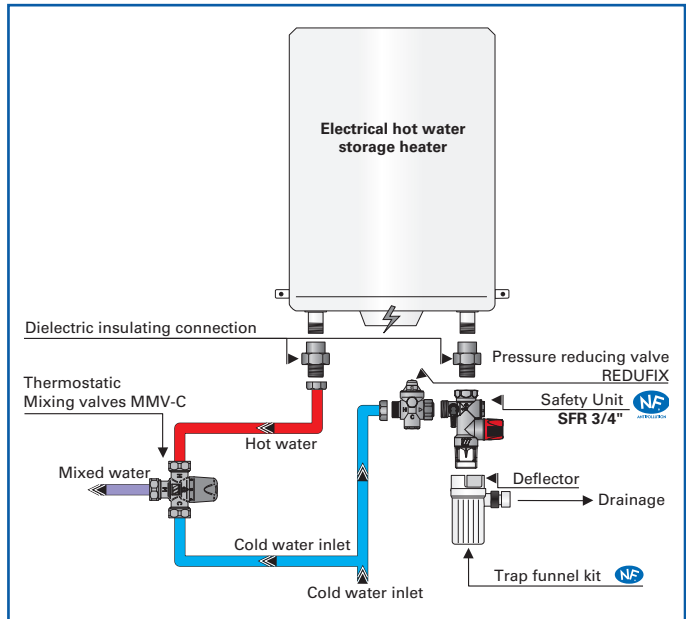

CASE OF TOWER BLOCKS :

Case No. 1 : 6-storey building - « Normal » water mains pressure : 6 bar - Desired pressure in each flat : 3 bar.

In the case of a residential building, it is advisable to install a pressure reducing valve at the input of each flat, and not a centralised pressure reducing valve at the bottom of the building.

Why ? : we should consider a height of 3 metres for each storey, a load loss per storey of 0.3 bars.

Therefore, if you install a single central pressure reducing valve at the bottom of the building adjusted to 3 bars, the first storeys will be supplied at the right pressure, but the more you go up the storeys, the more the pressure will drop.

For example, the 6th floor will have only 1.4 bars of available pressure, too low.

It is therefore necessary to install the same pressure reducing valve, adjusted to 3 bars, at the entry of each flat.

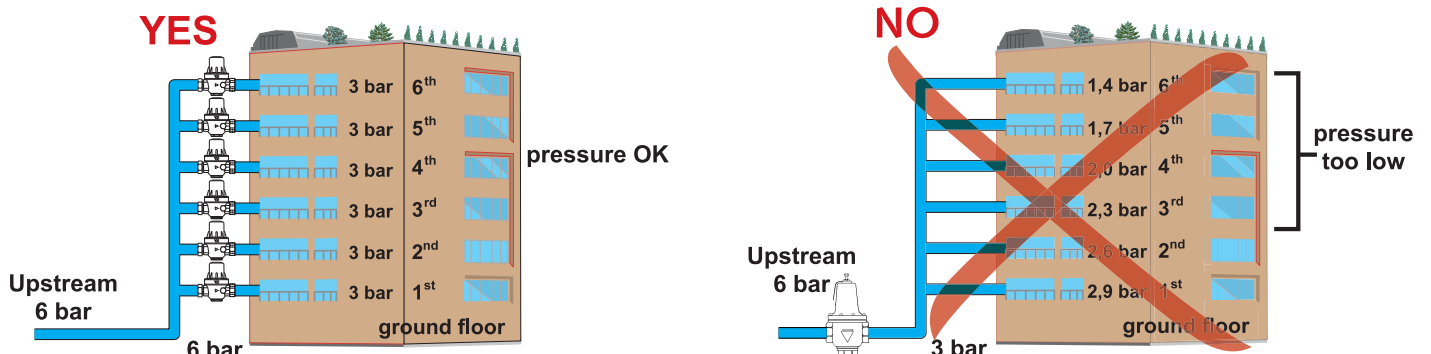

Case No. 2 : Building of more than 6-storeys - « High » water mains pressure : 10 bar - Desired pressure in each flat : 3 bar.

In the case of a residential building where the mains water pressure is very high, you are advised to install on the main inlet a pressure reducing valve of a larger diameter, which will firstly reduce the pressure to 6 bars, and a pressure reducing valve adjusted to 3 bars at the entry of each flat.

The vertical columns are thus protected by the larger pressure reducing valve, and each level by a smaller pressure reducing valve to give a pressure of 3 bars.

Remark : For very high buildings, the highest storeys do not require the installation of a pressure reducing valve when the pressure is less than 3 bars.

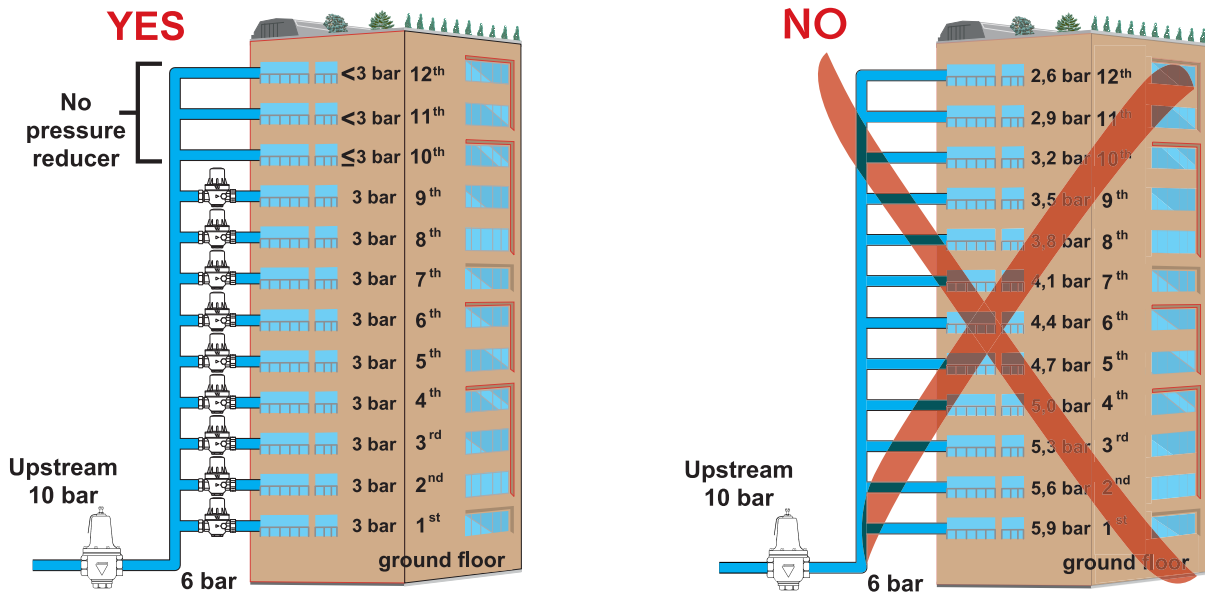

Case No. 3 : Building of more than 6-storeys - « Low » water mains pressure : 3 bar - Desired pressure in each flat : 3 bar.

In this case, the installation of a pressure booster is necessary. This will be adjusted to a value of 5 or 6 bars, the purpose being to obtain adequate pressure at all floors.

It is therefore necessary to install the same pressure reducing valve, adjusted to 3 bars, at the entry of each flat.

Remark : again, for very high buildings, the highest storeys do not require the installation of a pressure reducing valve when the pressure is less than 3 bars.

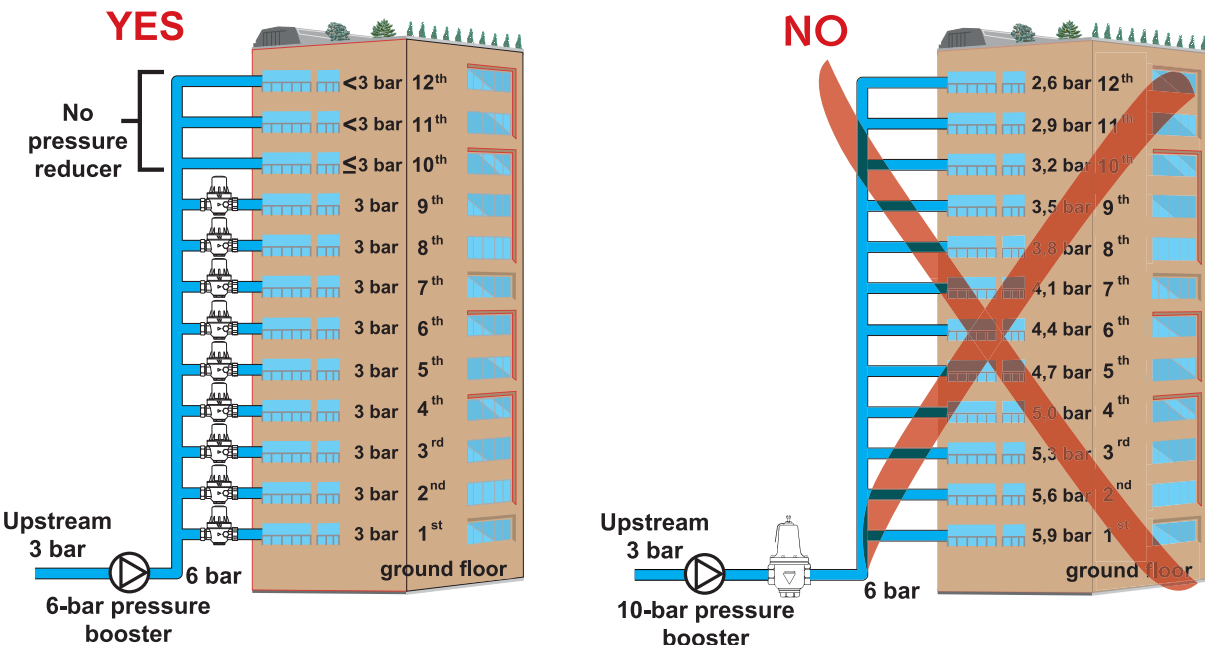

APPLICATION GUIDE

To choose the most suitable products, follow the applications and sub-applications below :

The pressure reducing valve market is segmented by Applications :

STANDARD USES

<p>- Protection of electrical water heaters and isolated appliances : Protection of isolated appliances (electrical hot water storage heater, washing machine, etc.)</p>		
<p>- REDUFIX 1/2" to 3/4"</p>		
<p>- Building and domestic installation – STANDARD installation : Individual water supply (flat, bungalow, etc.)</p>		
<p>- PRECISIO 1/2" to 3/4"</p>		
<p>- Water supply, industry and collective installations : Water supply to swimming pools, hotels, sports grounds, campsites, hospitals, office blocks, watering of parks and public gardens, schools, etc.</p>		
<p>- PRECISIO 1/2" to 3/4"</p>	<p>- REGLEAU GC 1" to 3"</p>	<p>- PR500 with flanges DN50 to DN250</p>

SPECIFIC USES

<p>- Building and domestic installation – installation without PARTICULAR PRESCRIPTION : Individual water supply <i>for low-cost building sites</i> (flat, bungalow, etc.).</p>		
<p>- REDUPRESS 1/2" to 3/4"</p>		
<p>- Industry and collective installation : Water supply needing protection of the pressure reducing valve diaphragm (collective hot water storage tank) and / or filtering (fire protection network) :</p>		
<p>- U5B with by-pass with built-in upstream filter 1/2" to 2"</p>		
<p>- VERY LOW pressure installation : Irrigation, breeding farms, laboratories, etc.</p>		
<p>- REDUPRESS low pressure 0,5 to 2,5 bar 1/2" to 3/4"</p>		
<p>- Installation after water meter :</p>		
<p>- PRECISIO swivel nut Swivel female nut / Male 3/4"</p>	<p>- HYDROBLOC 5 in 1 5 functions after meter</p>	

CASE OF TOWER BLOCKS

<p>- Main water supply, industry and collective installations</p>		
<p>- PRECISIO 1/2" to 3/4"</p>	<p>- REGLEAU GC 1" to 3"</p>	<p>- PR500 with flanges DN50 to DN250</p>

WRAS APPROVED PRODUCT



REDUFIX pressure reducing valve

Pressure reducing valve with piston and diaphragm, is designed for protecting single appliance like water storage heaters and household appliances.

Maintenance free robust device.

It is directly fitted upstream of the appliance that you want to protect or to water circuit inlets that you want to protect (kitchen, bathrooms, garden piping etc.).

Assembly any position.

Max. inlet pressure : 15 bar.
Max. temperature : 70°C.

Body and head in DZR brass, corrosion resistant.

Adjustable : 1,5 to 5 bar.
Delivered preset at 3 bar.

WRAS APPROVED PRODUCT



Diaphragm in NBR.
Female 1/4" pressure gauge outlet.

- Compact
Takes up less space, easier to fit, and is unobtrusive underneath water heaters.

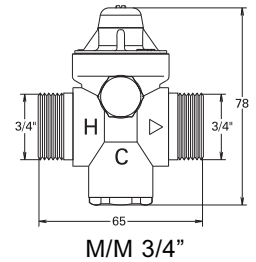

- Any position
The REDUFIX can be fitted in any position.

- Robust
Once fitted you can forget it.
The REDUFIX does not require any special maintenance.

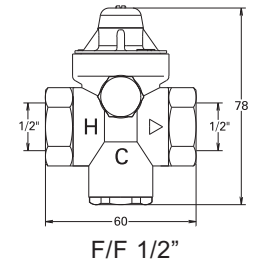

- Silent
The valve system design and types of seals used ensure operation with no vibration and no rattling about.

- Specific discharge
Discharge is appropriate to isolated appliances like washing machines or water heaters. It performs a role in better thermostatic mixer control and controlled water consumption.

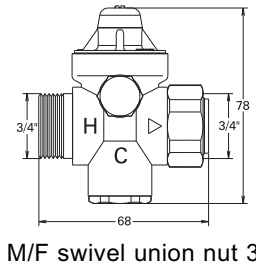

- Practical
Its Female 1/4" pressure gauge port is located on the front and not under the valve.

WRAS APPROVED PRODUCT



Article number 82210 : special for safety group

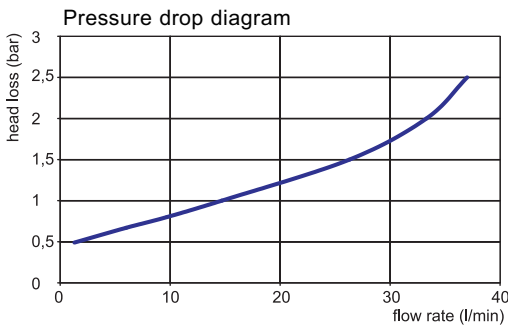
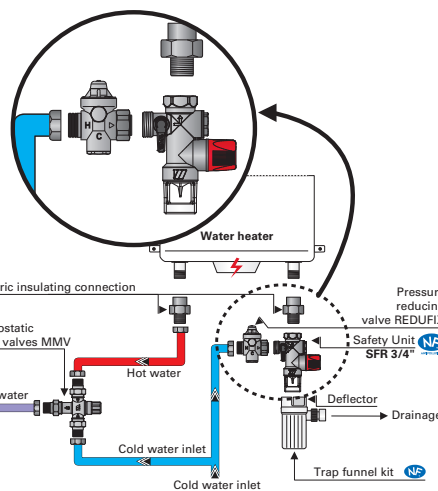

Under the following conditions : 8 bar inlet, 3 bar outlet

diameter		presentation	ref. code
F/F 1/2"	(15x21)	Box	82000
M/F 3/4" swivel union nut	(20x27)	Box	82210
M/F 3/4" swivel union nut	(20x27)	Under hull	82211
M/M 3/4"	(20x27)	Box	82110
M 3/4 (20x27) and F 1/2" (15x21)		Box	82007
DN 15 compression fitting		Box	82114
DN 22 compression fitting		Box	82115

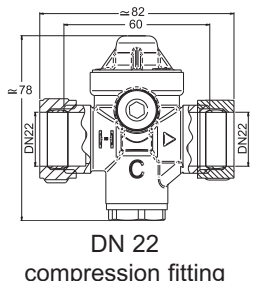
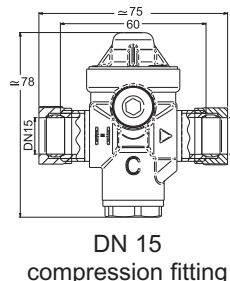



PRECISIO pressure reducing valve

Specially adapted to water installations in flats and houses, PRECISIO is more convenient, reduces water circulation noises and guarantees compliance with sound level requirements.

Max. inlet pressure : 25 bar.

Adjustable : 1,5 to 5 bar.
Delivered preset at 3 bar.

Body and head in DZR brass, corrosion resistant.

Max. temperature : 80°C.

Regulation is achieved by harnessing the diaphragm to a disc-yoke assembly.

Approval : NF EN 1567.

Seat Stainless Steel.

The screw and nut system allows easy setting adjustment.



Two 1/4" (8x13) side connections for pressure gauge.

- Reduced the pressure without reducing the flow. Thanks to its low pressure loss, it is possible to obtain a normal flow when there are multiple demands on the system.

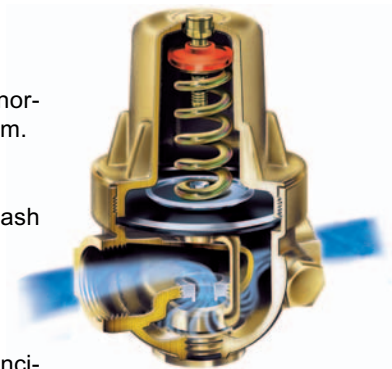

- Respect the standards of comfort and acoustics. The water hunting is less noisy and the taps do not splash any more.

- Maintenance free robust device.

- Dimensions allowing the interchangeability with the principal reducers of the market.

- Assembly any position.

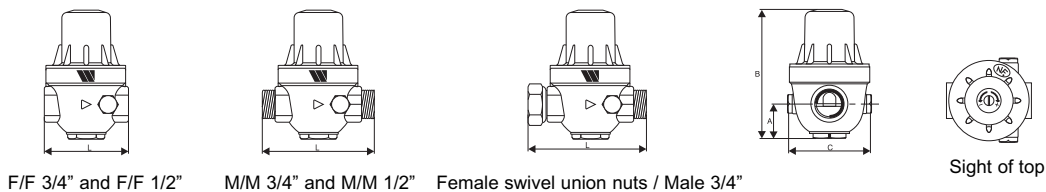
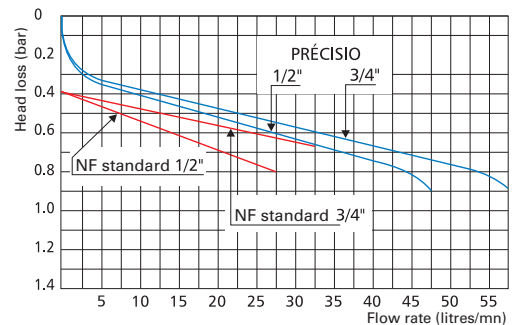
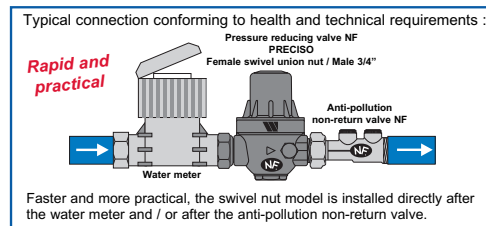

model	ref. code	L (mm)	A (mm)	B (mm)	C (mm)	weight (kg)
Female/Female 3/4" (20x27)	86200	76	30,5	115	72	0,975
Female/Female 1/2" (15x21)	86201	76	30,5	115	72	1,020
Male/Male 3/4" (20x27)	86210	100	30,5	115	72	1,065
Male/Male 1/2" (15x21)	86211	100	30,5	115	72	1,065
Female swivel union nuts / Male 3/4" (20x27)	86215	104	30,5	115	72	1,115

diameter	type	ref. code
F/F 1/2" (15x21)	Precisio F 1/2"	86201
F/F 3/4" (20x27)	Precisio F 3/4"	86200
M/M 1/2" (15x21)	Precisio M 1/2"	86211
M/M 3/4" (20x27)	Precisio M 3/4"	86210
Female swivel union nuts / Male 3/4"	Precisio ET 3/4"	86215

Upstream pressure 20 bar



REGLEAU G.C. pressure reducing valve

Pressure reducing valve with disc-yoke and diaphragm.

Max. temperature : 70°C.

- Yoke and diaphragm assembly : cast solid moving part highly sensitive spring and large diaphragm permits accurate adjustment and excellent performances.

Max. inlet pressure : until 20 bar.

- Stainless spring with large coils and high sensitivity : it guarantees a precise adjustment.

Adjustable : 1,5 to 5,5 bar.
Delivered preset at 3 bar.

- Diaphragm and valve high temperature : resisting high temperatures (up to 70°C).

Flow : until 40 m³/h.

Assembly any position

- Stainless steel seat : an exclusive design which protects the valve from the aggressive wear of water. A guarantee of longevity.

For hot or cold water.

Seat : stainless steel.

Body : bronze.

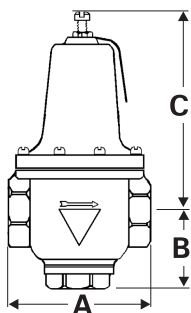
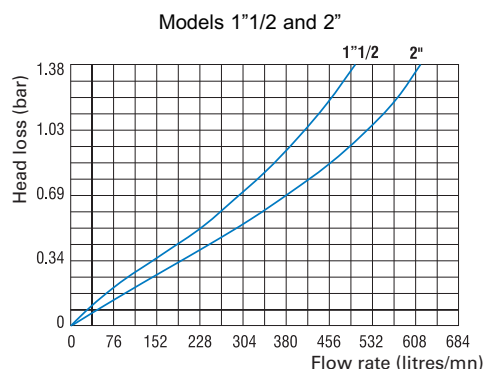
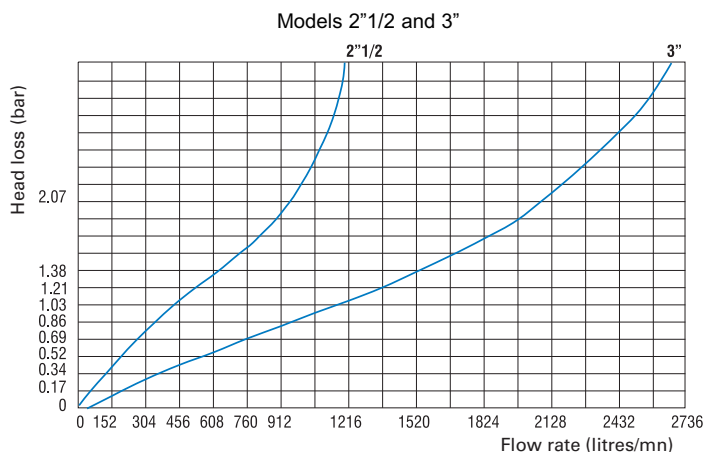
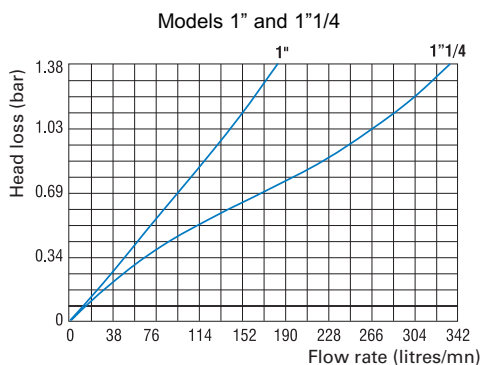

diameter		A (mm)	B (mm)	C (mm)	type	ref. code
F/F 1"	(26x34)	121	54	165	Regleau G.C.	28602
F/F 1 1/4"	(33x42)	127	70	172	Regleau G.C.	28603
F/F 1 1/2"	(40x49)	171	70	251	Regleau G.C.	28604
F/F 2"	(50x60)	203	86	273	Regleau G.C.	28605
F/F 2 1/2 By-pass	(66x76)	200	73	273	Regleau G.C.	28616
F/F 3" By-pass	(80x90)	267	105	324	Regleau G.C.	28617



U5B pressure reducing valve with by-pass

Pressure reducing valve with yoke and diaphragm, with built-in filter and by-pass.

- Inlet swivel union nuts.
- Built in filter easily removable, upstream of the device.
- Large spring and diaphragm for a precise adjustment.
- Maintainability without special tools.
- Horizontal or vertical assembly, fluid going up.

Max. inlet pressure : until 20 bar.

Adjustable : 1,5 to 5,5 bar.
Delivered preset at 3 bar.

Max. temperature : 80°C.

Diaphragm : Nordel with nylon.
Valve : Buna.

Body bronze, seat and spring stainless steel.

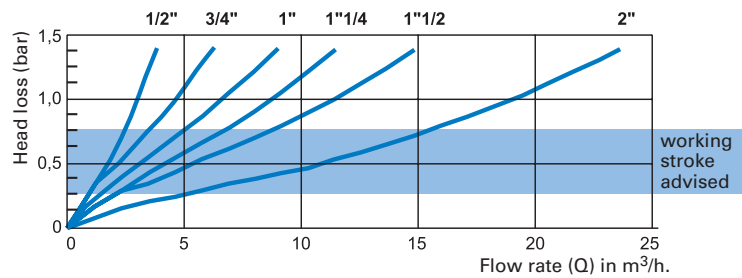
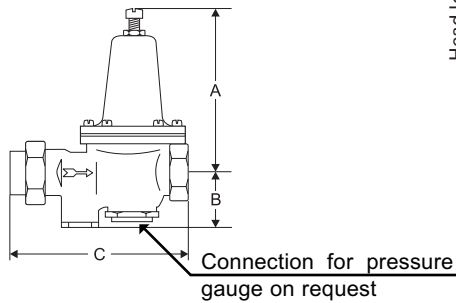

U5B standard : without pressure gauge port

U5B with 1/4" female pressure gauge port underneath valve (supplied with plug)

diameter	A (mm)	B (mm)	C (mm)	weight (kg)	ref. code U5B Standard	ref. code U5B pressure gauge
F/F 1/2" (15x21)	108	47	146	1,8	28100	28107
F/F 3/4" (20x27)	114	50	162	2,3	28101	28108
F/F 1" (26x34)	152	50	175	2,7	28102	28109
F/F 1 1/4" (33x42)	180	60	200	4,2	28103	28110
F/F 1 1/2" (40x49)	200	80	240	6,5	28104	28111
F/F 2" (50x60)	240	85	279	10,4	28105	28112
special monometer for U5B - reversed reading 0/10 bar						66106

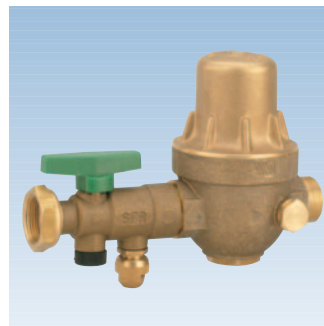

HYDROBLOC

After water meter 5 functions :

1. Connection 3/4" after water meter by swivel union nuts.
2. Stop valve to spherical plug.
3. Anti-pollution device.
4. Emptying device.
5. Pressure reducing valve with disc-yoke Preciso NF approval.

Ideal to save time and space = 5 functions, 1 only assembly!

Two 1/4" (8x13) side ports for pressure gauge.

Rough brass finished.

Max. inlet pressure : 16 bar.
Adjustable : 1,5 to 5,5 bar.

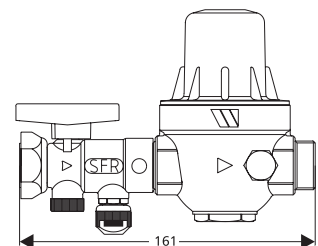

diameter	ref. code
HYDROBLOC - F/M 3/4" (20x27)	84010



REDUPRESS pressure reducing valve

Pressure reducing valve with piston and diaphragm.

Max. temperature : 80°C.

Ideal pressure reducing valve for domestic, commercial and industrial installations : Individual water supply for low-cost building sites (flat, bungalow, etc.).

Adjustable : 1,5 to 5,5 bar.

Max. inlet pressure : 16 bar.

Two 1/4" (8x13) side connections for pressure gauge.

Body : corrosion resistant DZR brass, nickel finished.

Diaphragm in EPDM.

Adjustment of setting by screw and nut mechanism.



SPECIAL LOW PRESSURE MODEL* :

Adjustable : 0,5 to 2,5 bar.

Max. inlet pressure : 8 bar.

Flow : 25 L/min. under 0,5 bar.

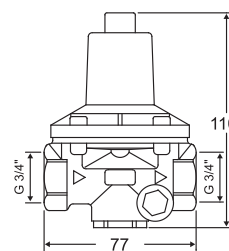

F/F 3/4"

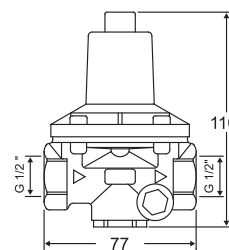

F/F 1/2"

Pressure drop diagram for standard REDUPRESS 1,5 to 5,5 bar

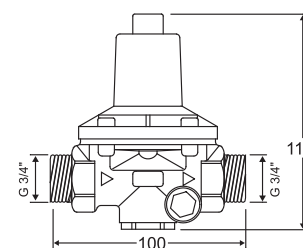
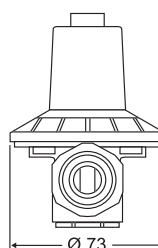
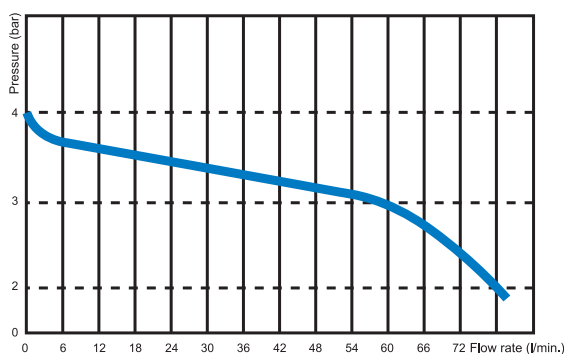

M/M 3/4"

diameter	type of pressure	ref. code
F/F 1/2"	standard pressure	81100
*F/F 1/2"	low pressure	81106
F/F 3/4"	standard pressure	81116
*F/F 3/4"	low pressure	81113
M/M 3/4"	standard pressure	81015
F/F 1/2" with manometer	standard pressure	81101
F/F 3/4" with manometer	standard pressure	81117
M/M 3/4" with manometer	standard pressure	81016
Manometer 0 to 10 bar		66206



WATTS PR500 pressure reducing valve with flanges

For all the drinkable water supply networks : building, distribution of water, industry, pumping.

Max. pressure : 25bar
Max. temperature : 20°C
Adjustable : 1 to 7 bar,
(see cavitation curves).

Stabilizes automatically the pressure downstream with the regulated value.

Very simple adjustment of the pressure by system screw and nut.
Body cast iron covered epoxy integral interior, outside
Seat : stainless.

Simple construction.
Minimum maintenance.

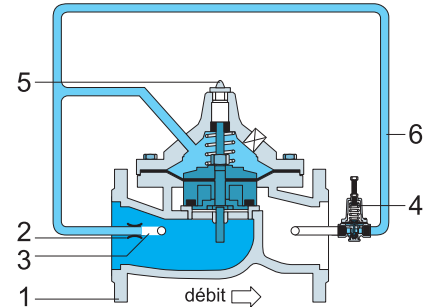

- 1 - Body / Main valve
- 2 - Fixed orifice
- 3 - Flow strainer
- 4 - Pilot valve
- 5 - Air vent
- 6 - Flexible tubing

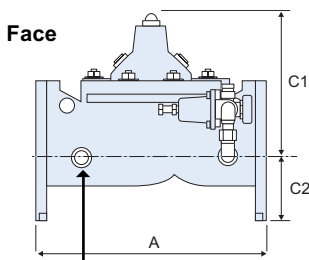

upstream pressure gauge connection

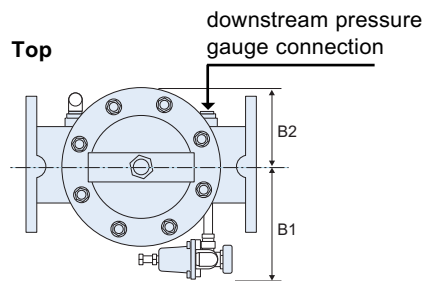

models	DN	PN	A (mm)	B1 (mm)	B2 (mm)	C1 (mm)	C2 (mm)	weight (kg)	pressure gauge connections
PR500-50	60	16	290	170	85	165	95	25	F 3/8"
PR500-65	65	16	290	170	85	165	95	25	F 3/8"
PR500-80	80	16	310	175	85	165	100	30	F 3/8"
PR500-100	100	16	350	190	120	210	110	40	F 1/2"
PR500-125	125	16	400	200	150	285	125	70	F 1/2"
PR500-150	150	16	480	210	150	285	145	90	F 1/2"
PR500-200	200	16	600	235	200	360	170	150	F 1/2"
PR500-250	250	16	730	280	255	475	200	400	F 1/2"

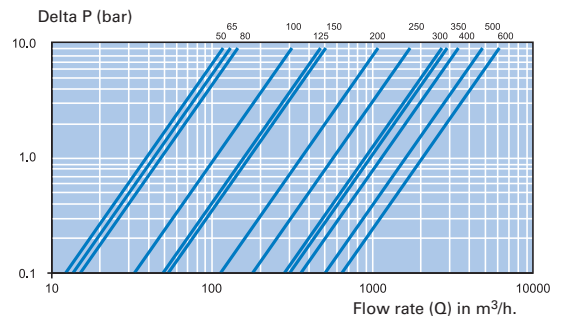
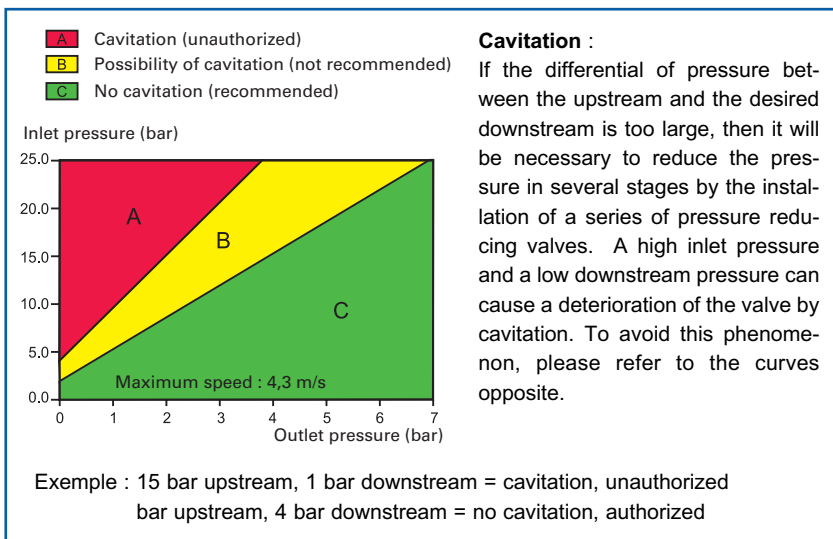

diameter	range	type	ref. code
DN 50	1 to 7 bar	PR500 PN16	500 050 546
DN 65	1 to 7 bar	PR500 PN16	500 065 546
DN 80	1 to 7 bar	PR500 PN16	500 080 546
DN 100	1 to 7 bar	PR500 PN16	500 100 546
DN 125	1 to 7 bar	PR500 PN16	500 125 546
DN 150	1 to 7 bar	PR500 PN16	500 150 546
DN 200	1 to 7 bar	PR500 PN16	500 200 546
DN 250	1 to 7 bar	PR500 PN16	505 200 546

Product range Watts Industries

- System disconnectors
- Backflow protection devices
- Check valves
- Safety units
- Safety relief valves
- Pressure reducing valves
- Automatic control valves
- Butterfly valves
- Shut off valves
- Measuring gauges
- Temperature control
- Expansion vessels
- Process switches
- Fuel products
- Gas products
- Electronic controls
- Installation protection products
- Radiator valves
- System products
- Manifolds and fittings



A Division of Watts Water Technologies Inc.

WATTS INDUSTRIES France

06, avenue Gustave Eiffel - B.P. 40339 - 28006 CHARTRES Cedex (France)

Phone +33 (0)2 37 25 11 00 - Fax +33 (0)2 37 25 11 11

E-mail info@wattseurotherm.fr - Site www.wattseurotherm.fr